

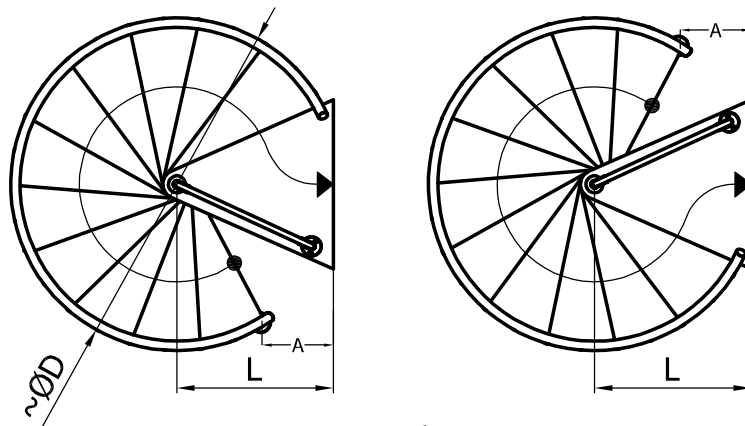

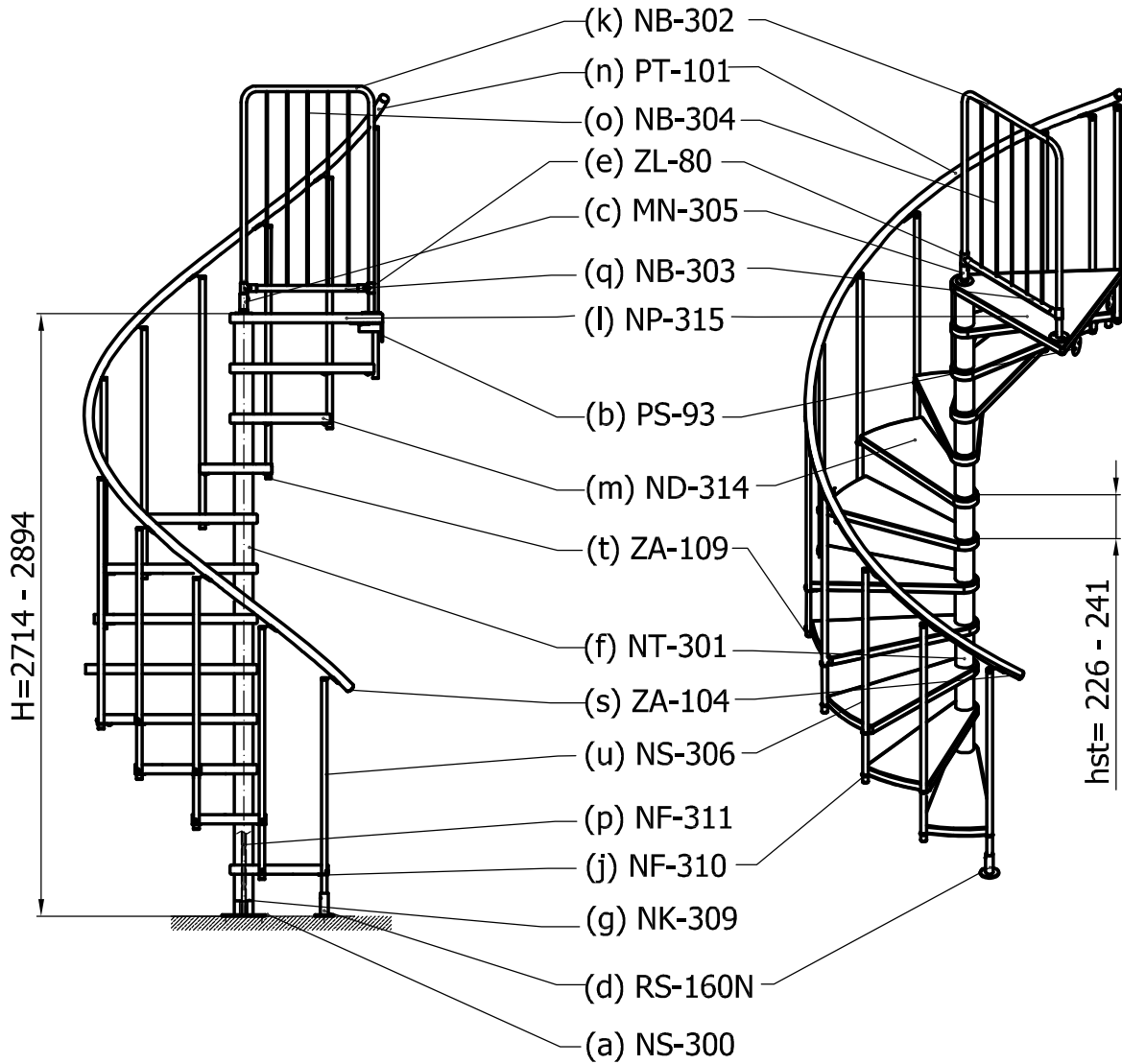

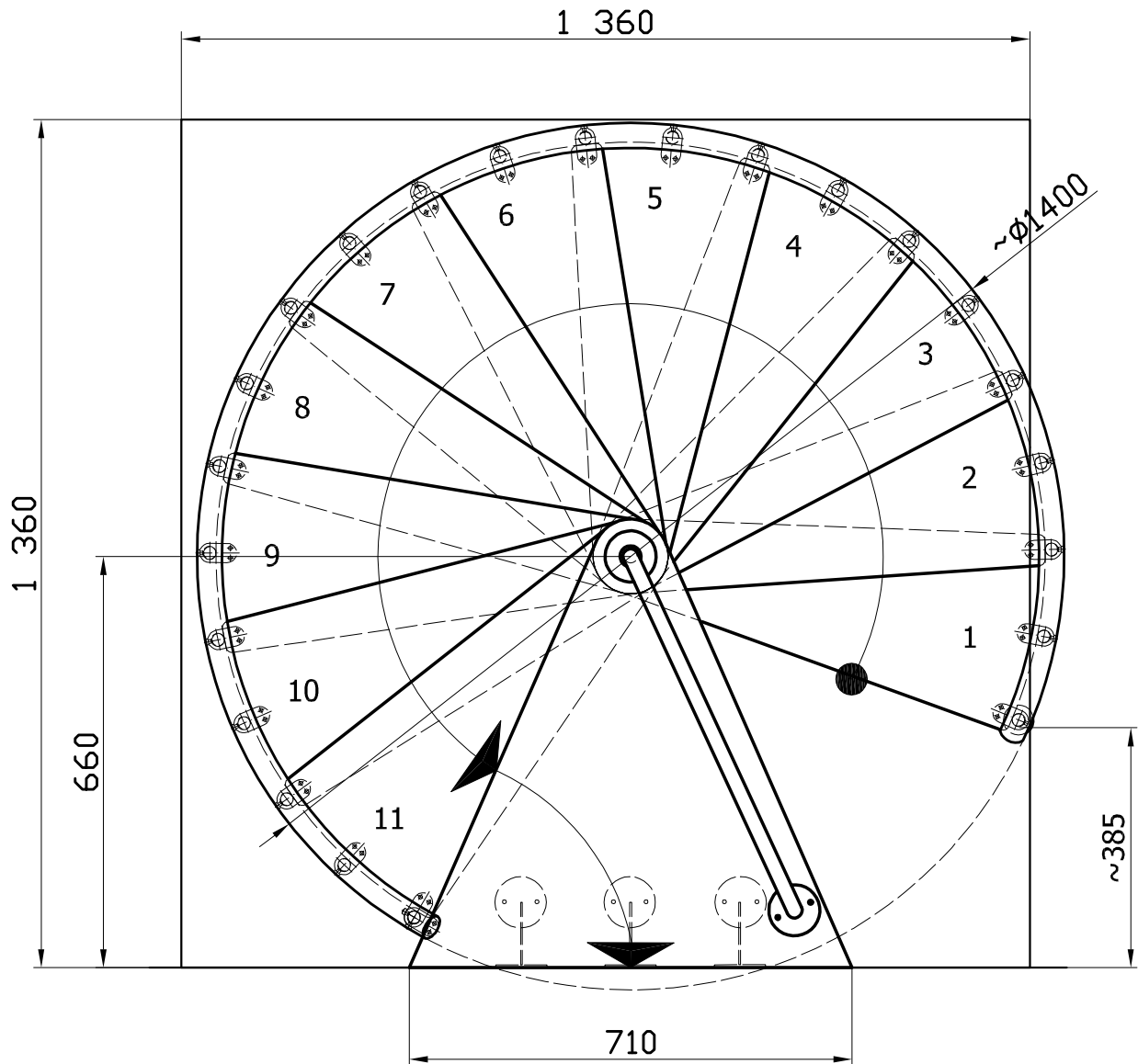





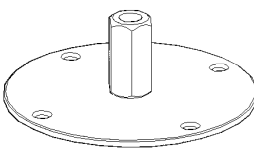
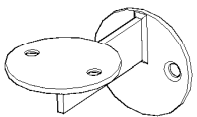
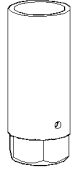
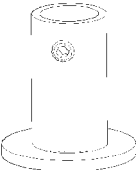
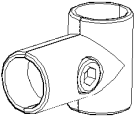
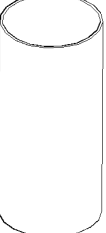
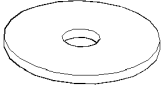
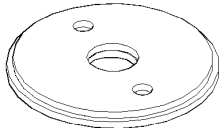
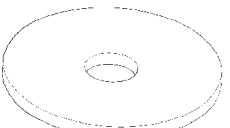
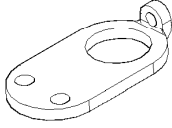
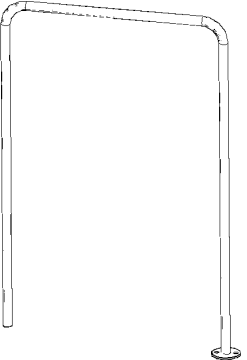
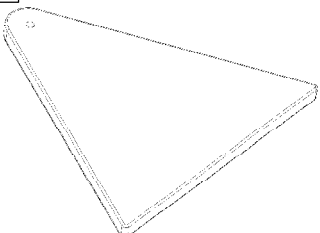
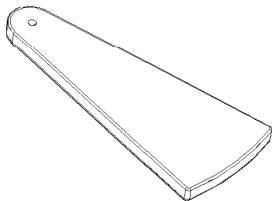
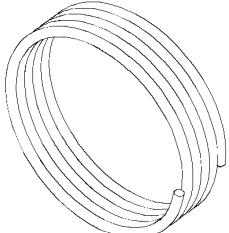
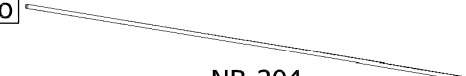

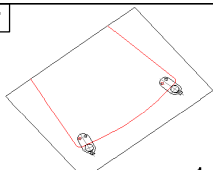
# ATRIUM NOVO typ 2

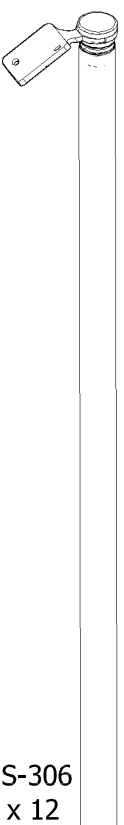
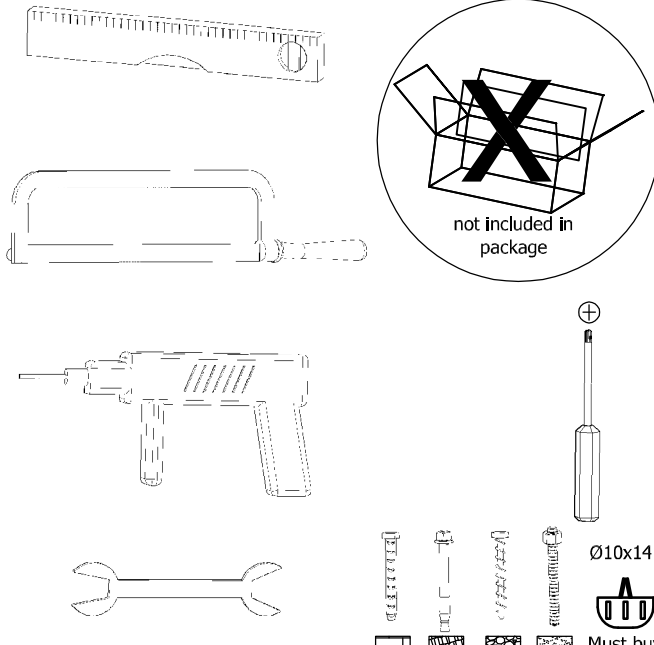
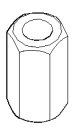

D: Ø 1400  
 L: 660  
 A: ~385

# ATRIUM NOVO Ø1400

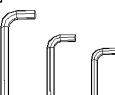

<p><b>a</b></p>  <p><b>NS-300</b> x 1</p>	<p><b>b</b></p>  <p><b>PS-93</b> x 3</p>	<p><b>c</b></p>  <p><b>NM-305</b> x 1</p>	<p><b>d</b></p>  <p><b>RS-160N</b> x 1</p>	<p><b>e</b></p>  <p><b>ZL-80</b> x 2</p>	
<p><b>f</b></p>  <p><b>NT-301</b> x 12</p>	<p><b>g</b></p>  <p><b>NK-309</b> x 1</p>	<p><b>h</b></p>  <p><b>NK-308</b> x 23</p>	<p><b>i</b></p>  <p><b>NK-307</b> x 37 Option 1: x 0 Option 2: x 13 Option 3: x 25 Option 4: x 37</p>	<p><b>j</b></p>  <p><b>NF-310</b> x 23</p>	
<p><b>k</b></p>  <p><b>NB-302</b> x 1</p>	<p><b>l</b></p>  <p><b>NP-315</b> x 1</p>	<p><b>m</b></p>  <p><b>ND-314</b> x 11</p>	<p><b>n</b></p>  <p><b>PT-101</b> x 4,5 m</p>		
<p><b>o</b></p>  <p><b>NB-304</b> 5 x 0,89 m</p>		<p><b>p</b></p>  <p><b>NF-311</b> x 3 m</p>			
<p><b>q</b></p>  <p><b>NB-303</b> x 1</p>	<p><b>r</b></p>  <p>x 1</p>	<p><b>s</b></p>  <p><b>ZA- 104</b> x 2</p>	<p><b>t</b></p>  <p><b>ZA- 109</b> x 11</p>	<p><b>u</b></p>  <p><b>NS-306</b> x 12</p>	
 <p>not included in package</p> <p>Ø10x14 Must buy</p>		<p><b>p1</b></p>  <p><b>NF-312</b> x 2</p>	<p><b>p2</b></p>  <p><b>NF-313</b> x 6</p>		<p><b>k1</b></p>  <p><b>SR-143</b> x 2</p>
<p><b>n1</b></p>  <p><b>3,5x16</b> x 25</p>		<p><b>d1</b></p>  <p><b>M8x10</b> x 2</p>	<p><b>j1</b></p>  <p><b>M6x12</b> x 23</p>		
<p><b>j2</b></p>  <p><b>WD-144</b> x 52</p>		<p><b>v</b></p>  <p><b>S3+S4+S6</b> x 1</p>	<p><b>w</b></p>  <p><b>ø20, L=40 cm</b></p>		

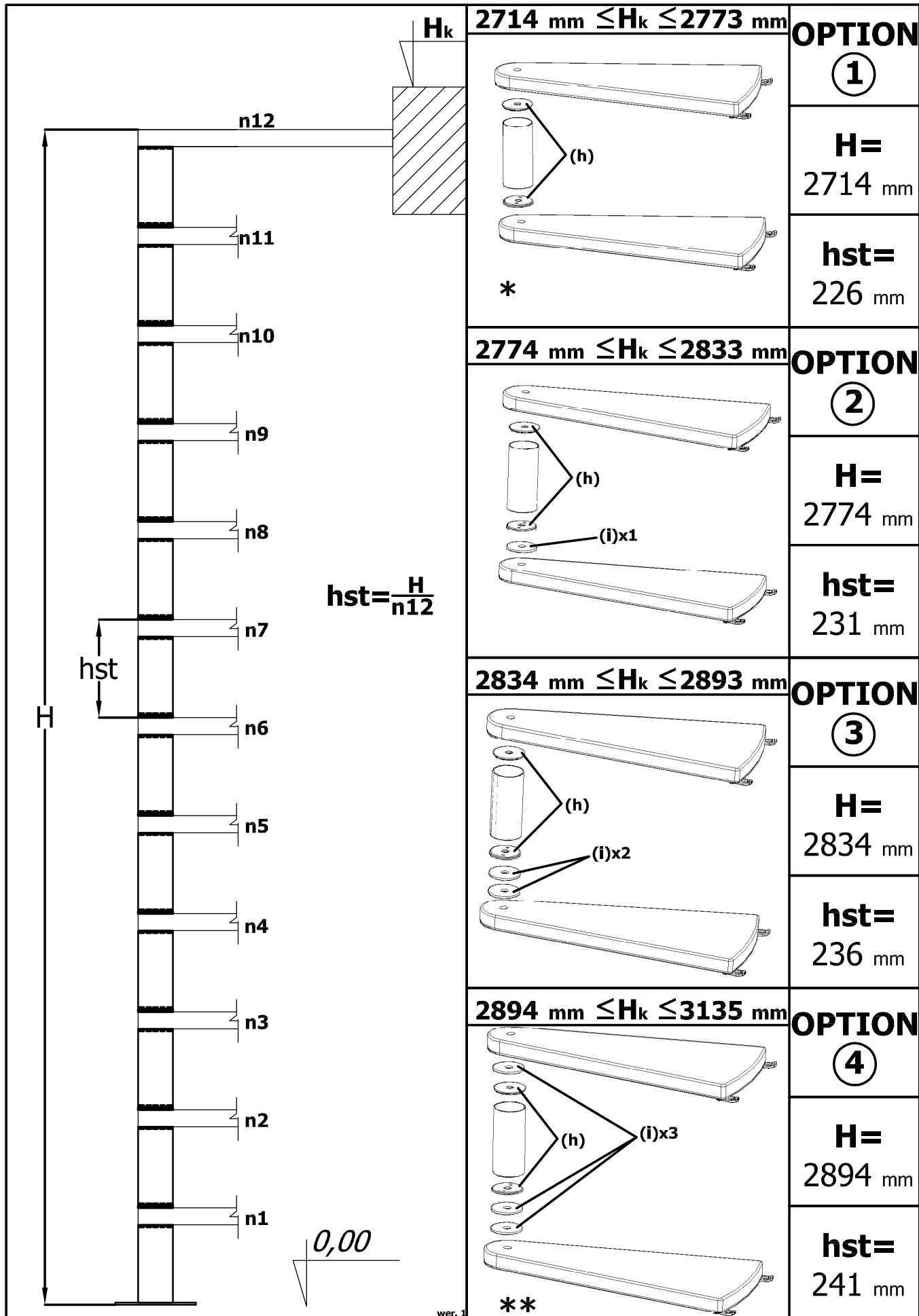

$2714 \text{ mm} \leq H_k \leq 2773 \text{ mm}$

**OPTION ①**

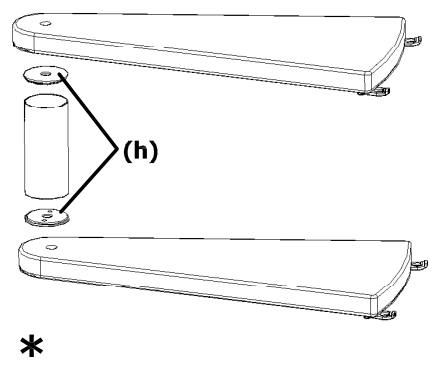

**①**

**H=**  
2714 mm

**hst=**  
226 mm

$2774 \text{ mm} \leq H_k \leq 2833 \text{ mm}$

**OPTION ②**

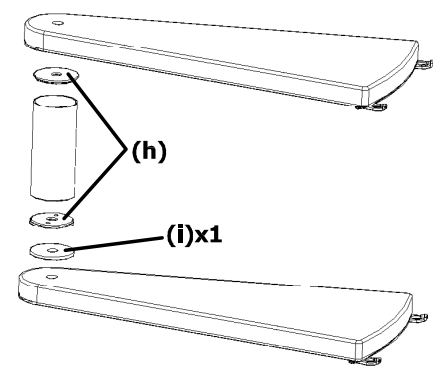

**②**

**H=**  
2774 mm

**hst=**  
231 mm

$2834 \text{ mm} \leq H_k \leq 2893 \text{ mm}$

**OPTION ③**

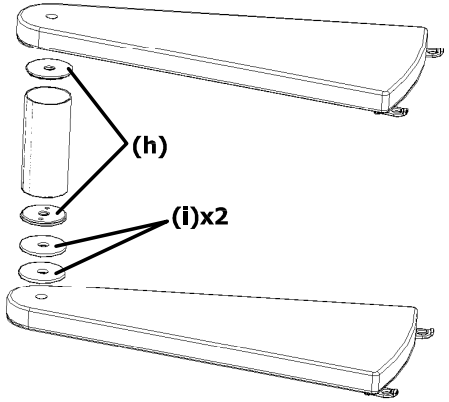

**③**

**H=**  
2834 mm

**hst=**  
236 mm

$2894 \text{ mm} \leq H_k \leq 3135 \text{ mm}$

**OPTION ④**

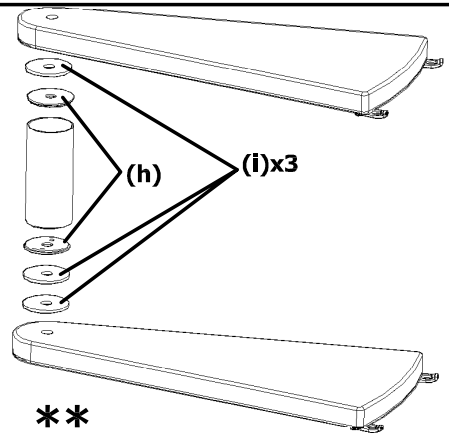

**④**

**H=**  
2894 mm

**hst=**  
241 mm

$hst = \frac{H}{n_{12}}$

0,00

