

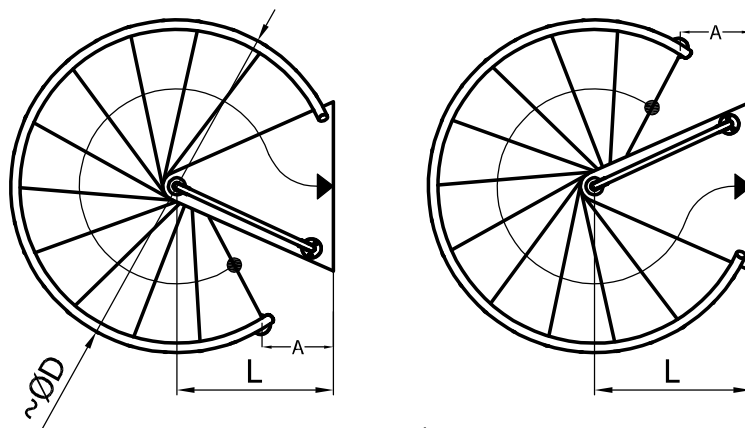

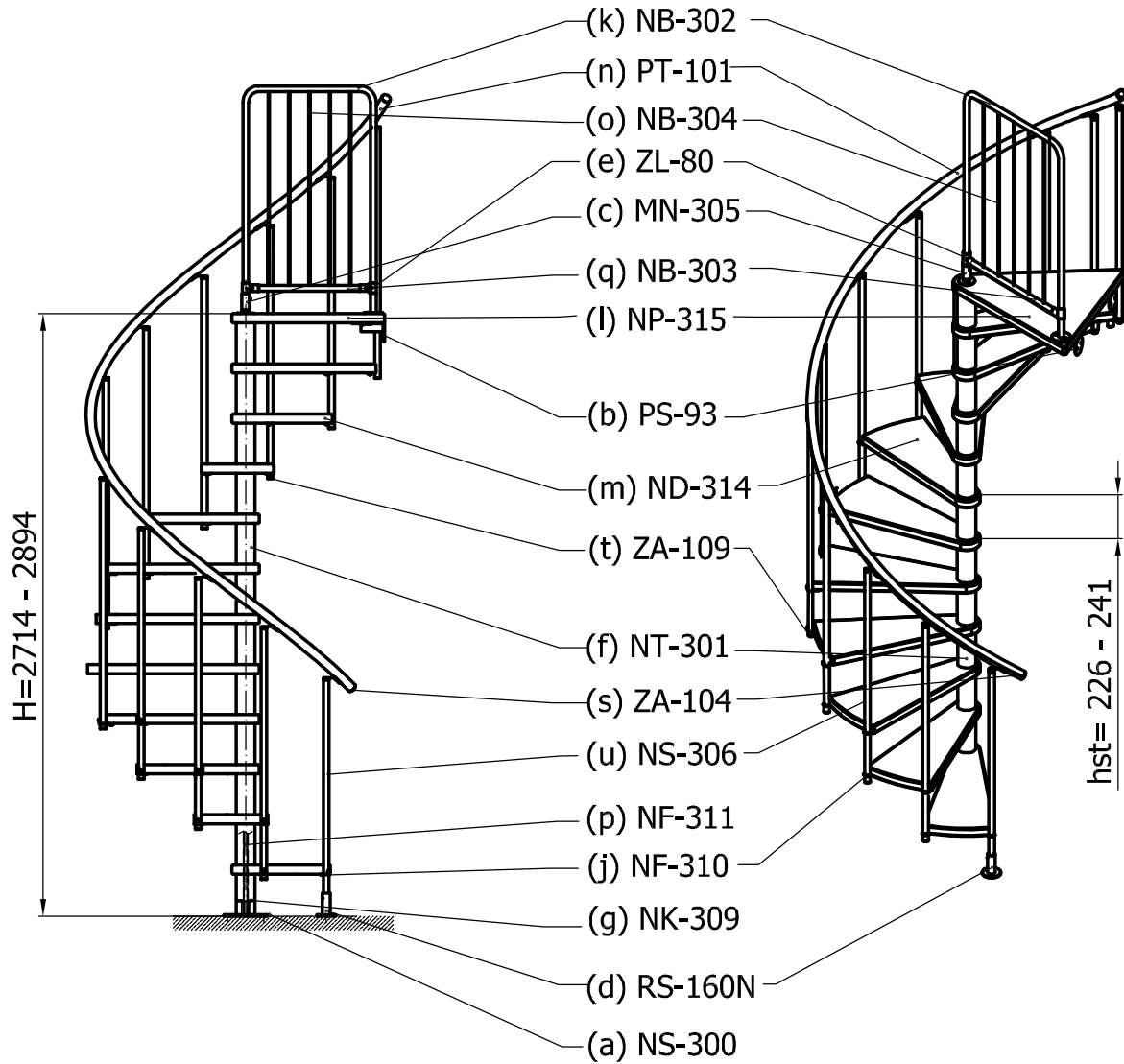

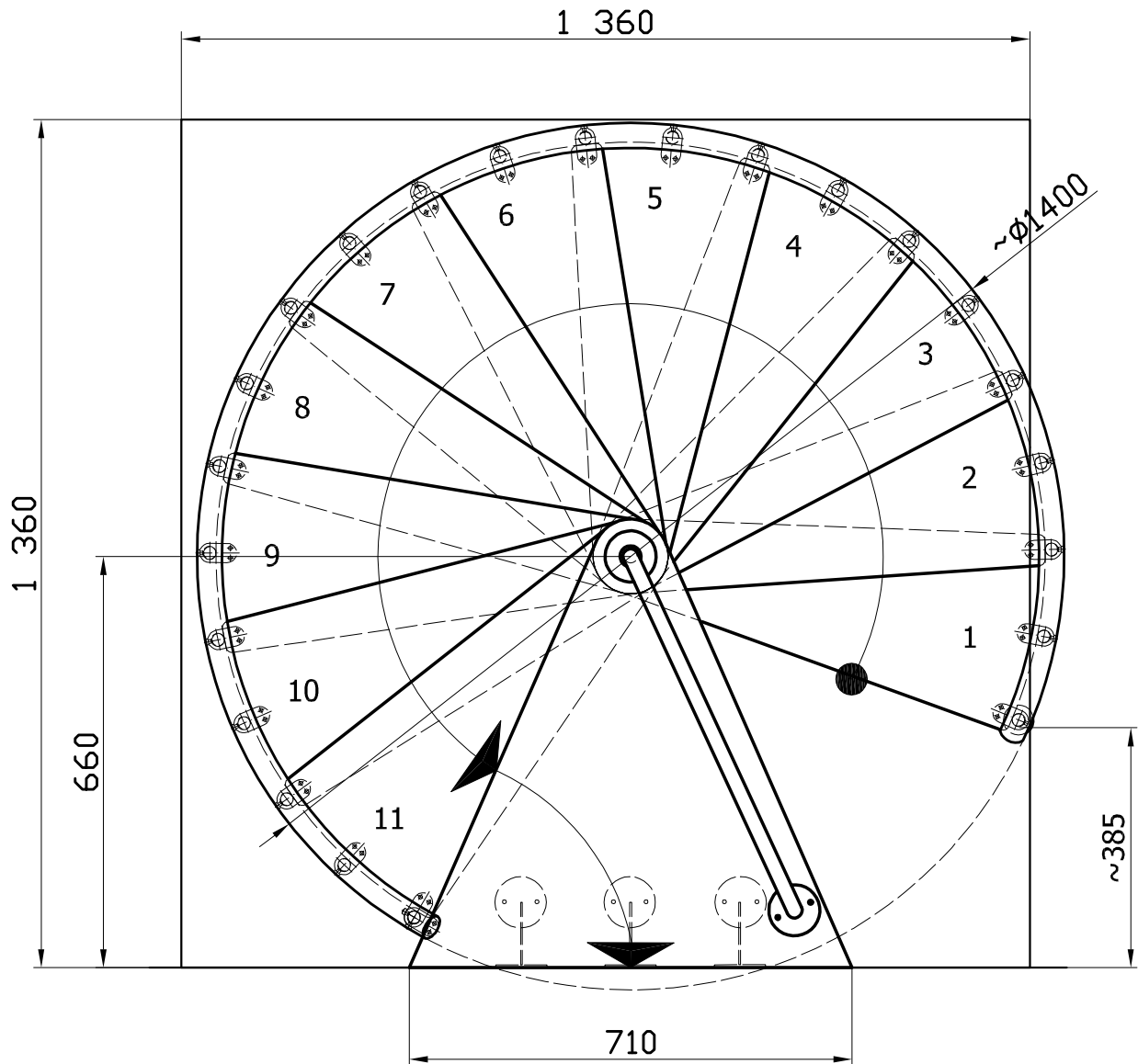





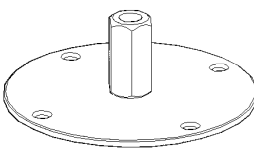
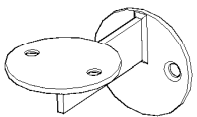
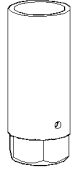
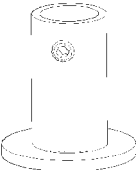
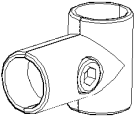
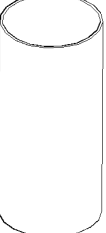
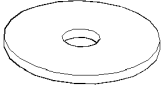
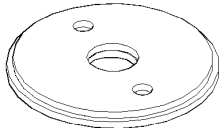
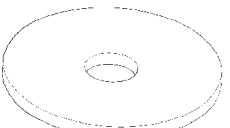
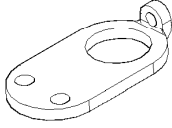
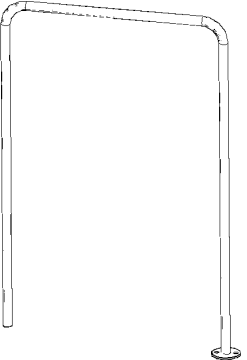
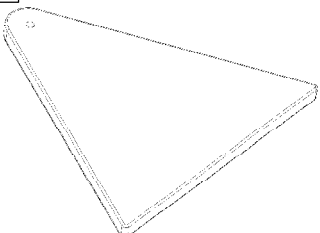
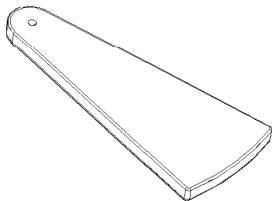
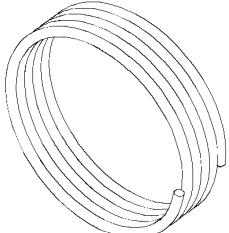
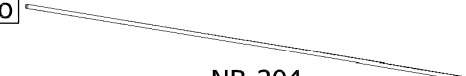

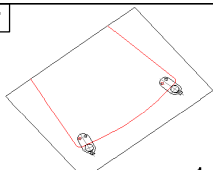
ATRIUM NOVO typ 2

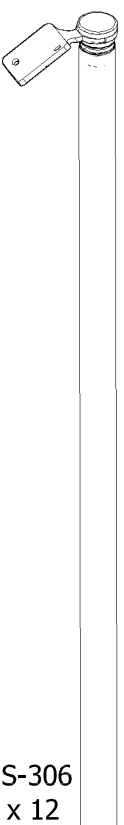
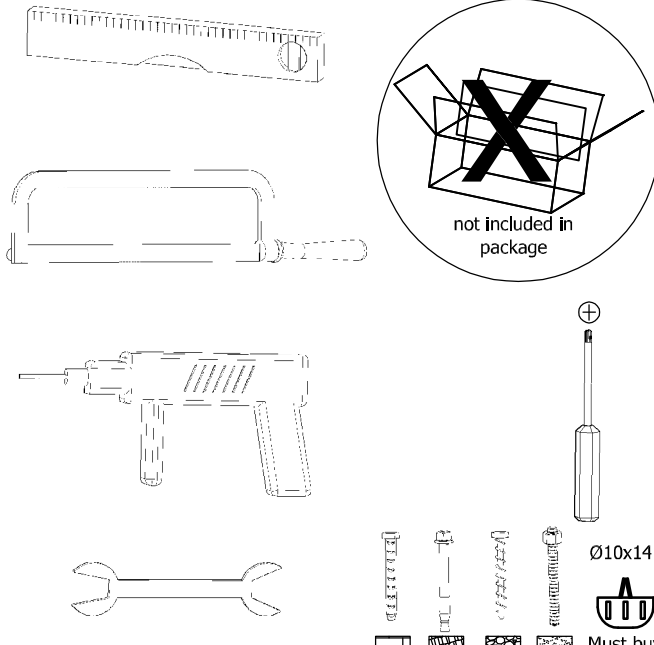
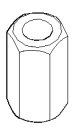

D: Ø 1400
 L: 660
 A: ~385

ATRIUM NOVO Ø1400

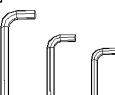

<p>a</p>  <p>NS-300 x 1</p>	<p>b</p>  <p>PS-93 x 3</p>	<p>c</p>  <p>NM-305 x 1</p>	<p>d</p>  <p>RS-160N x 1</p>	<p>e</p>  <p>ZL-80 x 2</p>	
<p>f</p>  <p>NT-301 x 12</p>	<p>g</p>  <p>NK-309 x 1</p>	<p>h</p>  <p>NK-308 x 23</p>	<p>i</p>  <p>NK-307 x 37 Option 1: x 0 Option 2: x 13 Option 3: x 25 Option 4: x 37</p>	<p>j</p>  <p>NF-310 x 23</p>	
<p>k</p>  <p>NB-302 x 1</p>	<p>l</p>  <p>NP-315 x 1</p>	<p>m</p>  <p>ND-314 x 11</p>	<p>n</p>  <p>PT-101 x 4,5 m</p>		
<p>o</p>  <p>NB-304 5 x 0,89 m</p>		<p>p</p>  <p>NF-311 x 3 m</p>			
<p>q</p>  <p>NB-303 x 1</p>	<p>r</p>  <p>x 1</p>	<p>s</p>  <p>ZA- 104 x 2</p>	<p>t</p>  <p>ZA- 109 x 11</p>	<p>u</p>  <p>NS-306 x 12</p>	
 <p>not included in package</p> <p>Ø10x14 Must buy</p>		<p>p1</p>  <p>NF-312 x 2</p>	<p>p2</p>  <p>NF-313 x 6</p>		<p>k1</p>  <p>SR-143 x 2</p>
<p>n1</p>  <p>3,5x16 x 25</p>		<p>d1</p>  <p>M8x10 x 2</p>	<p>j1</p>  <p>M6x12 x 23</p>		
<p>j2</p>  <p>WD-144 x 52</p>		<p>v</p>  <p>S3+S4+S6 x 1</p>	<p>w</p>  <p>ø20, L=40 cm</p>		

